

General

© Copyright 2003 by

FEIG ELECTRONIC GmbH

Lange Straße 4

D - 35781 Weilburg

The indications made in these operating instructions may be altered without previous notice.

With the edition of these instructions, all previous editions become void.

Composition of the information given in this manual has been done to the best of our knowledge. FEIG ELECTRONIC does not guarantee the correctness of the details given in these instructions and may not be held liable for damages ensuing from incorrect installation.

Since, despite of all our efforts, errors may not be completely avoided, we are always grateful for your useful tips.

The installation instructions given in this manual are based on advantageous boundary conditions. FEIG ELECTRONIC does not give any guarantee promise for perfect function of the traffic detector in a cross surrounding.

Copy or reproduction of these instructions, even if only partial, as well as translation into other languages is forbidden unless a written consent has been granted by FEIG ELECTRONIC. This also applies to the complete or partial storage of these operating instructions on modern input- and output media for further processing in data processing systems.

Please read the operating- and safety instructions thoroughly before putting the motion detector into operation!!



Q-SAQ INC 2735 Center PL STE 104 Melbourne, FL 32940 USA

Email: info@q-saq.com P: 1-321-248-6749 www.vehicle-accesscontrol.com

Contents

1	Functional description	19
2	Installation.....	20
	2.1 Place of installation.....	20
	2.2 Mounting of the holding angle	20
	2.3 How to connect the motion detector	20
	2.4 How to screw down the housing.....	20
3	Adjustment and Initiation.....	22
	3.1 Direction identification	22
	3.2 Device address.....	23
	3.3 LED display.....	23
	3.4 Fall-delay time of relay.....	23
	3.5 Personal suppression.....	23
	3.6 Adjustment with key buttons	24
	3.6.1 Selection of sensitivity	24
	3.6.2 Personal suppression.....	24
	3.6.3 Factory setting.....	24
	3.7 Adjustments with the infrared remote control MWD RC.....	24
	3.7.1 How to activate the adjustment mode.....	24
	3.7.2 Selection of sensitivity	25
	3.7.3 Personal suppression	25
	3.7.4 How to terminate the adjustment mode	25
	3.8 Adjustment of the detection zone.....	25
	3.9 Initiation procedure.....	26
	3.10 Possible reasons of malfunctions	26
4	Technical Data	27
5	Safety instructions	28
6	Certificate of approval.....	29
7	Short survey.....	31

1 Functional description

The MWD BF is a radar motion detector with direction identification, which has been especially designed for applications in the sector of industrial door and barrier systems. In some cases, the operational parameters may also be adjusted with an infrared remote control.

Motion detection is done according to the Doppler's principle. The sensor sends out 24 GHz microwaves. These microwaves are reflected by objects in motion and thus their frequency changes. The sensor receives these altered frequencies and analyses them. Thus, each motion within the detection range is recorded, analysed by a logic and transmitted to the door or barrier control by connecting potential-free change-over contacts.

Range of application:

Entry / access recognition for the drive of industrial door and barrier systems

Special features:

- Insensitive to fluctuations of temperature and humidity
- Distinction between vehicles / personel
- Reversible and cutoff direction logic
- Adjustable sensitivity
- Potential-free relay exit with change-over contacts
- Large supply voltage range - AC or DC
- Adjustment of operational parameters by key buttons or infrared remote control
- Compact plastic housing
- IP 65 housing
- Easy and fast installation with mounting bracket

2 Installation

2.1 Place of installation

The device is centrally mounted above the sector to be monitored. Both wall and ceiling fixing are possible. The maximum mounting height is approx. 6m.

ENGLISH

Hints for planning and installation:

- The device has to be mounted *vibrationless*.
- In order to avoid spurious detection, there must not be *any objects in motion within the radiation field*.
- There must not be *any fluorescent tubes* within the radiation field of the detector.
- It should be avoided that the radiation fields of two motion detectors overlap, since this may lead to spurious detection.
- Do not install behind objects, building coverings or elements.
- If the motion detector is exposed to rain or snow, it should be adjusted to directional recognition.
- If *conductive floors* are used and the radiation direction is almost vertical, spurious releases may be caused by reflections.

2.2 Angle of the mounting bracket

The mounting bracket is suitable for both wall and ceiling suspension. In case of ceiling suspension, it has to be turned by 180° opposite the housing of the motion detector.

2.3 How to connect the motion detector

Connection is done as shown in figure 2. Fix the leads of the flexible connecting cable 10 cm from the appliance, lead it through the lateral PG-screwing and fix it. In case of DC power supply, polarity is not important.

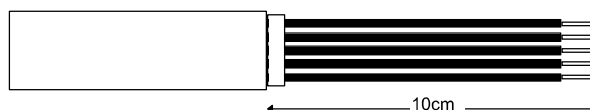

2.4 How to screw down the housing

The cover should be screwed down with a torque of approx. 1 Nm. Put the cover evenly into the groove of the housing and screw it down.

Attention! *If the cover is not even, for example due to squeezed cable leads in between the screw guides, the tightness of the housing is impaired!*

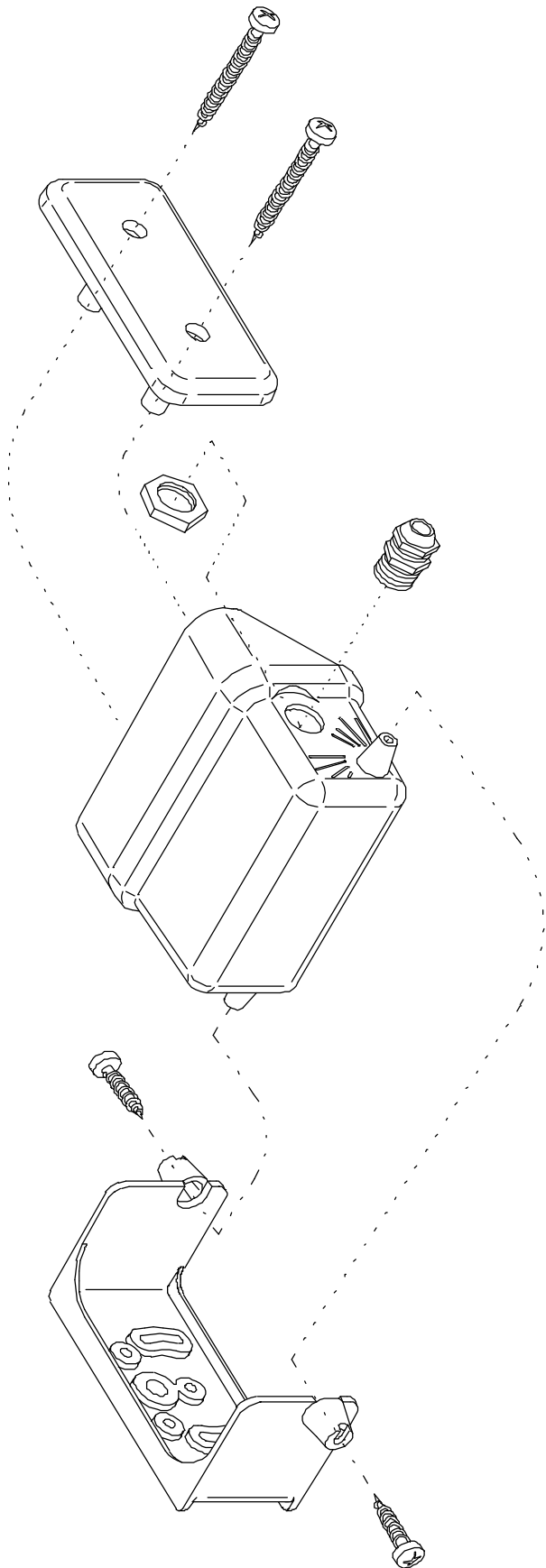

Figure 1: Magnified diagram of the housing.

3 Adjustment and Initiation

ENGLISH

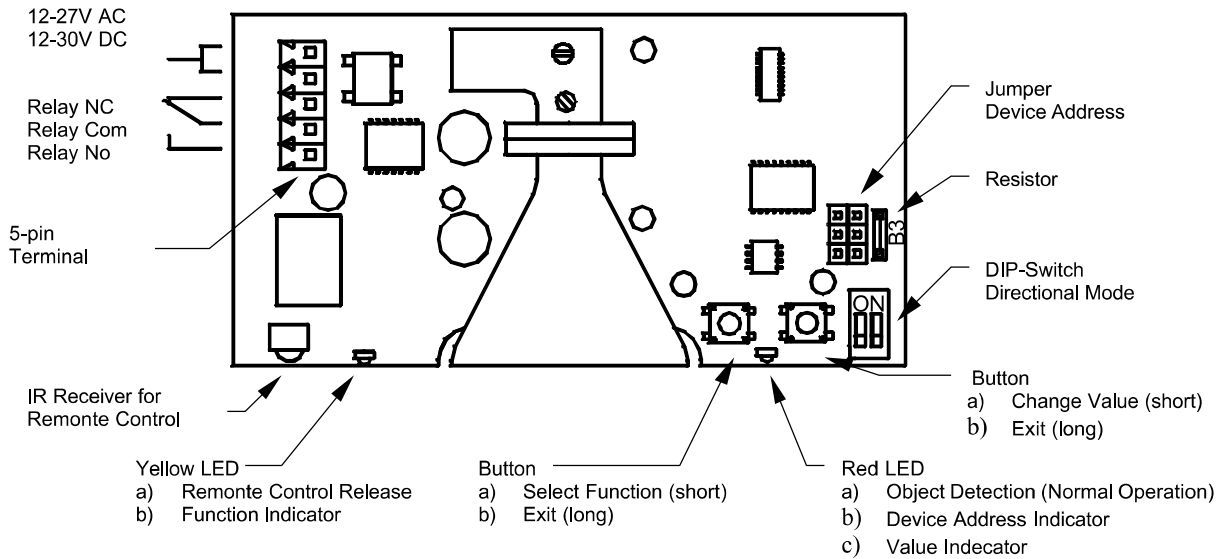





Figure 2: Operating elements on the printed board





3.1 Direction identification

The direction identification device of the motion detector may be adjusted by the DIP-switches located on the right side. DIP-switch No. 1 is assigned to *approaching* objects, which is adjusted most often. If DIP-switch Nr. 2 is switched on, the device reacts to objects that are *moving away from* the motion detector. If both DIP-switches are switched on or off, the direction identification is deactivated.

Direction identification	DIP-switch	
	1	2
<i>approaching</i>	 1 2	ON OFF
<i>moving away</i>	 1 2	OFF ON
off	 1 2	OFF OFF
	 1 2	ON ON

3.2 Device address

In order to be able to adjust neighbouring motion detectors with a remote control, an address may be assigned to each appliance in sectors 1-4. For this purpose, a jumper field is located above the DIP-switches.

Address	Jumper position
1	
2	
3	
4	

3.3 LED display

Mode of operation	Yellow LED – left side	Red LED – right side
object recognition	off	object identified
adjustment with key button	flash signals for function numbers	flash signals acc. to parameter significance
adjustment with remote control	a) reception readiness for infrared remote control b) flash signals for function numbers	a) flash signals acc. to parameter significance b) flash signals for device address

3.4 Off-delay time of relay

The factory setting for the off-delay time of the relay is 0,5 seconds.

An extension of the off-delay time to 2 seconds may be reached by removing the resistor which is located next to the jumpers for the device address (figure 2).

Warning: *The resistor may only be cut through in the de-energised state !
Please make sure that no components or strip conductors are damaged !*

3.5 Personal suppression

If personal suppression is activated, the appearance of single persons will not trigger the device. For more information regarding adjustment of personal suppression, please see section 3.6.2 resp. 3.7.3.

Personal suppression is designed for the use in typical internal traffic situations. Deviating conditions (very low or high mounting height, setting angle is too steep or too flat, oblique mounting position) or untypical objects (e.g. fast moving persons, groups, very slow vehicles, high-lift trucks with fabric rolls etc.) may lead to malfunctions if personal suppression is activated.

3.6 Adjustment with key buttons

Operational parameters (sensitivity, personal suppression) may be adjusted with the buttons located at the right side of the horn antenna.

ENGLISH

<i>Left button / yellow LED:</i>	<i>select/indicate function</i>
<i>Right button / red LED:</i>	<i>change/indicate value</i>

If a function is selected for the first time, the function number is indicated on the yellow LED, followed by the currently set value on the red LED.

The adjustment process is terminated automatically 30 seconds after the last button has been pressed or by pressing a button for a longer time.

3.6.1 Selection of sensitivity

The sensitivity of the motion detector may be adjusted by degrees from 1 to 15. Each time the right button is pressed, the sensitivity is increased by one degree. Degree 15 is followed by degree 1.

<i>Yellow LED</i>	<i>flashes</i>	<i>1x</i>
<i>Red LED</i>	<i>flashes</i>	<i>1 x acc. to value of the current degree of sensitivity</i>

3.6.2 Personal suppression

The personal suppression of the motion detector may be activated (position 1) and de-activated (position 2) by using the button on the right side.

<i>Yellow LED</i>	<i>flashes</i>	<i>2x</i>
<i>LED rot</i>	<i>flashes</i>	<i>1x if personal suppression is activated 2x if personal suppression is de-activated</i>

3.6.3 Factory setting

In order to reset the parameters to the factory setting, both buttons are pressed while switching on power supply. Now, the following adjustments are made:

<i>Degree of sensitivity:</i>	<i>7</i>
<i>Personal suppression:</i>	<i>off</i>

3.7 Adjustments with the infrared remote control MWD RC

3.7.1 How to activate the adjustment mode

Before the parameters of a motion detector can be changed with the remote control, the appliance has to be activated for this adjustment. For this purpose, please press the -key. Now, all motion detectors within the range of reception of the remote control will indicate the set device address on the red LED. If the address of the desired device is entered within 3 seconds by the number keys of the remote control, the activated device shows its readiness for entry on the yellow LED. All other appliances are not activated and return to their normal mode.

3.7.2 Selection of sensitivity

After the device has been cleared, the sensitivity of the motion detector may be changed with the keys ◀ and ▶. When the keys are pressed for the first time, the yellow LED indicates the number of the desired function with flash signals. The adjusted value is indicated by flash signals of the red LED. Sensitivity ranges from 1 to 15.

Yellow LED	flashes	1x	(function 1)
Red LED	flashes	1 x acc. to value of current sensitivity level	

Notice: Please switch off personal suppression when adjusting sensitivity.

3.7.3 Personal suppression

The -key changes the setting of the personal suppression.

Yellow LED	flashes	2x	(function 2)
Red LED	flashes	1x	if personal suppression is switched on
		2x	if personal suppression is switched off

3.7.4 How to terminate the adjustment mode

Adjustment with the remote control is terminated by pressing the -key. The motion detector now returns to the normal detection mode. The yellow LED is extinguished. The red LED now continues to indicate detected objects. The object recognition mode is automatically activated, if no entry has been made with the key buttons or remote control for 30 seconds.

3.8 Adjustment of the detection zone

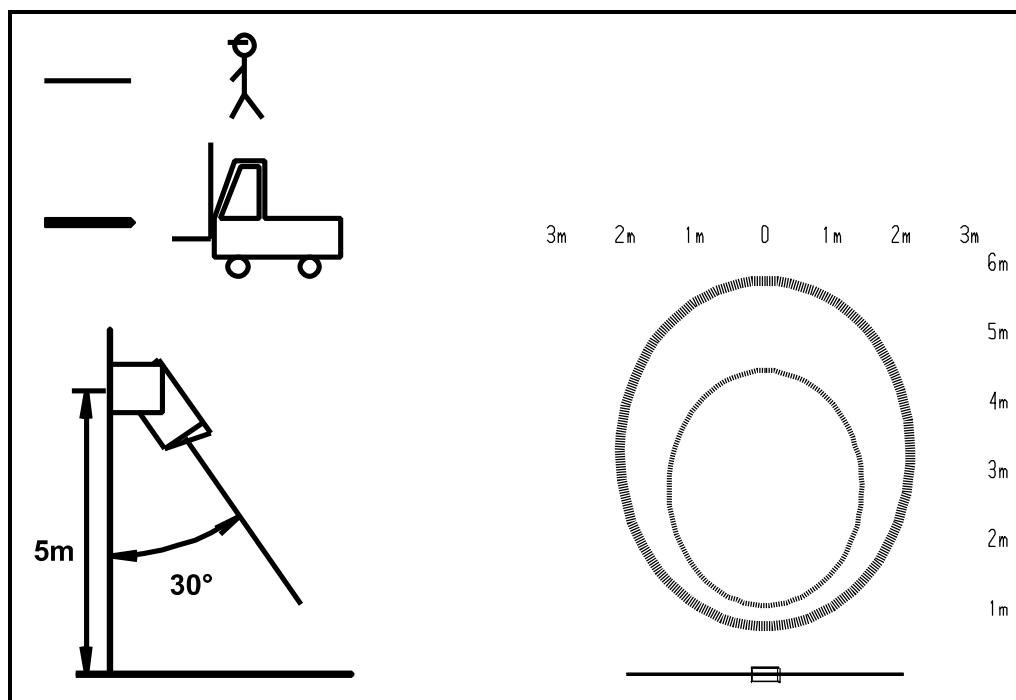

The MWD BF has a circular detection zone. Size and position of the detection zone may be altered by adjusting sensitivity and inclination angle. In general, the optimum inclination angle lies between 30° and 45°.

In order to change the angle of radiation, please loosen the lateral screws located between the mounting bracket and housing. On both sides of the housing there are division marks in a 15° grid system.

The size of the detection zone may change depending on the size and speed of the object to be detected. If the motion detector is mounted in a height of more than 4 meters and sensitivity is low, the detection zone for persons becomes very small.

3.9 Initiation procedure

- Sensitivity adjustment should always be done with the personal suppression mode being switched off. If need be, the personal suppression mode may then be activated and the function may be tested with a vehicle ($v > 10\text{km/h}$).
- The first attempts of putting the device into operation should be carried out with the opening system of the downstream door or barrier system being switched off. The personal suppression mode should be switched off as well.
- In order to test the device, please approach the motion detector from one point outside the detection field and observe the reaction of the device by means of the LED. This test should be carried out from all directions.
- With the help of the information gained by this test, the detection zone of the motion detector may be changed by using the sensitivity adjustment.
- The door or barrier control may now be put into operation again. After that, one trial run should be carried out with the door operating. If the motion detector reacts to the movements of the door, the inclination angle to the gate has to be increased, until this effect may not be noticed anymore.
- If need be, the size of the detection zone has to be re-adjusted by using sensitivity selection.

3.10 Possible reasons of malfunctions

- The reasons for malfunctions of the motion detector may be the following
 - moving parts in the surrounding area,
 - vibrations which are transmitted to the appliance through the mounting bracket,
 - electric disturbances in the connecting cable
 - or electric fields

4 Technical Data

Housing	Dimensions (without cable) 132 x 155 x 58 mm Colour black Housing pot plastic ASA Mounting bracket plastic ASA Cover plastic PC
Weight (incl. support bar)	0,3 kg
Protective system	IP 65
Distribution voltage	12-27 V AC 12-30 V DC
Power consumption	typ. 1,5 W max. 2,4 W
Admissible working temperature	-20 °C to +55 °C
Storing temperature	-30 °C to +75 °C
Air moisture	< 95 % non fogging
Frequency	24,125 GHz
Transmitting power	typ. 5 mW
Output relay	
max. switching voltage	24 V AC/DC
max. switching current	1 A at resistive load
min. switching current	1 mA
Contact type	1 change-over contact (potential-free) In case of inductive load please provide for an external protective wiring or the relay contacts !
Connecting cable	Flexible, max. 5x1,0 mm
Off-delay time of relay	0,5 s / 2 s , selection with jumper
Maximum mounting height	6 m
Adjustable functions	By means of sliding switch on printed card Direction recognition off/approaching/moving away By means of key button or infrared remote control Sensitivity Personal suppression Factory setting (only key buttons)
CE-relevant standards	ETS 300 683

5 Safety instructions

ENGLISH

- This device shall only be used for the purpose intended by the manufacturer.
- The operating instructions have to be handed out to each user and accessible at any time.
- Improper changes and spare parts resp. special features which are not sold or recommended by the manufacturer of the device may cause fires, electric shock and injuries. Such measures therefore lead to nonliability of the manufacturer and no guarantee will be given.
- For this device, the indemnity contract applies in the version valid at the time of purchase. We exclude liability for improper or wrong manual or automatic adjustment of parameters resp. improper use of the appliance.
- Repair work should only be carried out by the manufacturer.
- Connection, initiation, maintenance, measuring and adjustment of the motion detector should only be carried out by electrical engineers with accident prevention skills.
- When handling appliances which get into contact with electric current, VDE-rules have to be observed - especially VDE 0100, VDE 0550/0551, VDE 0700, VDE 0711, VDE 0860, VDE 0105 as well as the fire – and accident prevention standard VBG4.
- Please switch off power supply prior to opening the device and make sure that it remains off.
- If an indicator lamp goes out, this is not a proof that the device is without electricity and disconnected from power supply. All work that is carried out at the device as well as installation has to be carried out in conformance with the national electric regulations and the local rules.
- The user has to make sure that the appliance is mounted and connected according to the technical rules of the country of installation as well as other regional regulations. This applies especially to cable dimensioning, protection, earthing, cutoff, disconnection, isolation supervision and excess current cut-out.
- Low-voltage operation is not allowed at the relay outputs.
- The device can not be used as a safety device regarding to the Machinery Safety Directive 98/37/EG, the Construction Products Directive 89/106/EEC or other safety regulations. Using in systems with danger potential it is necessary to include additional protection devices.
- The hard gold alloy of the relay contacts is destroyed if switching currents of more than 100 mA are used. Relays with such pre-damaged contacts may only switch currents of more than 100 mA reliably!
- If the place of operation is located in direct proximity to foil gates, suitable measures have to be taken to branch off the electrostatic charging of the gate foil.

6 Certificate of approval

Europe (CE)

CETECOM ICT Services GmbH

EC Identification number 0682

authorized by the German Government



with decree Vfg 28/2000, issued in the Official Journal 6/2000
of the Regulierungsbehörde für Telekommunikation und Post,
to act as Notified Body in accordance with the R&TTE Directive 1999/5/EC of 09. March 1999.

CERTIFICATE EXPERT OPINION

Registration-No.: **E811674M-EO**
 Certificate Holder: **FEIG ELECTRONIC GmbH**
Lange Str. 4
D-35781 Weilburg-Waldhausen

Product Designation: **MWD BF**
 Product Description: **Radar Movement Detector**
 Product Manufacturer: **FEIG ELECTRONIC GmbH**
Lange Str. 4
D-35781 Weilburg-Waldhausen

Essential requirements	Specifications / Standards	Submitted documents	Result
Radio spectrum (R&TTE, Article 3.2)	ETSI I-ETS 300 440 (1995-12) BAPT 211 ZV 3/2099(1994-04)	Test Report Approval Certificate G115672E	conform

Marking: The product shall be signed with CE, our notified body number and the Class II identifier (Alert sign) as shown right hand.



The scope of this evaluation relates to the submitted documents only.
The certificate is only valid in conjunction with the following number of annexes.

Number of annexes: **1**

Saarbrücken, 07.12.2000
Place, Date of Issue

Signed by Lothar Spitzer
Notified Body



CETECOM ICT Services GmbH, Untertürkheimer Straße 6-10, D-66117 Saarbrücken, Germany
<http://www.cetecom.de>

USA (FCC)

ENGLISH

FCC ID: PJMMWDBF

This device complies with part 15 of the FCC Rules. Operation is subject to the following two conditions:

- (1) This device may not cause harmful interference, and
- (2) this device must accept any interference received, including interference that may cause undesired operation.

Unauthorized modifications may void the authority granted under Federal communications Commission Rules permitting the operation of this device.

This device is for use only within a building or to open building doors.

7 SHORT SURVEY

Operating elements and pin configuration:

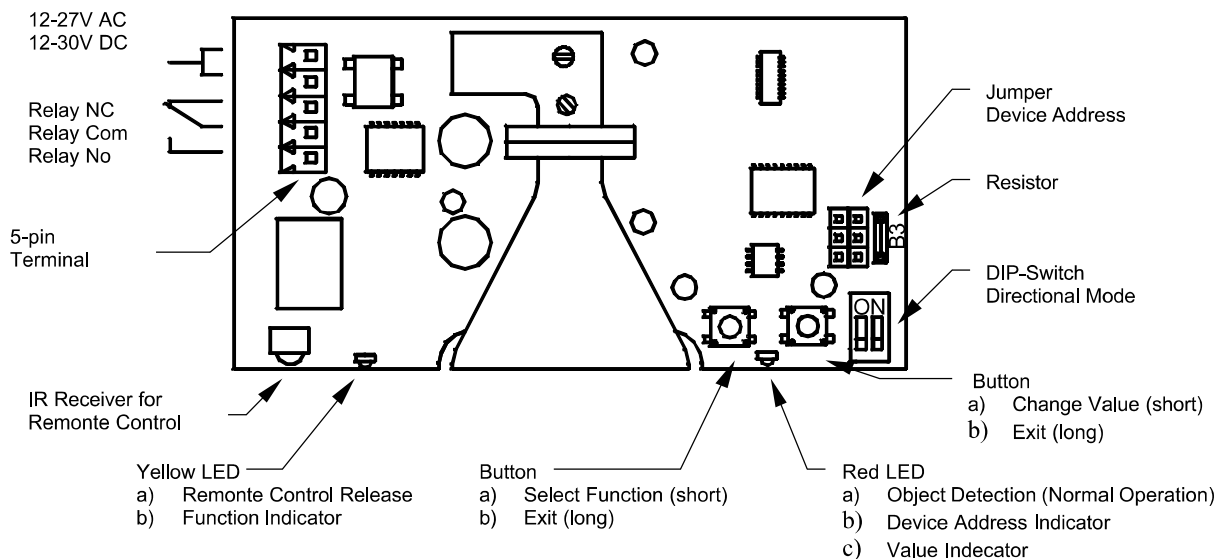

ENGLISH

Direction recognition	DIP-switches	
	1	2
<i>Off</i>		OFF OFF
		ON ON
<i>Approaching</i>		ON OFF
<i>Moving away</i>		OFF ON

Device address for remote control	Jumper position
1	
2	
3	
4	

Remote control key	Function	Flash signal of LED Left right	Adjustment range
	Acivation	Ready Address	1 .. 4 (address)
	Sensitivity	1x current value	1=low .. 15=high
	Extraction of persons	2x current value	1=on 2=off
<i>i</i>	-	-	-